

Turboen puller

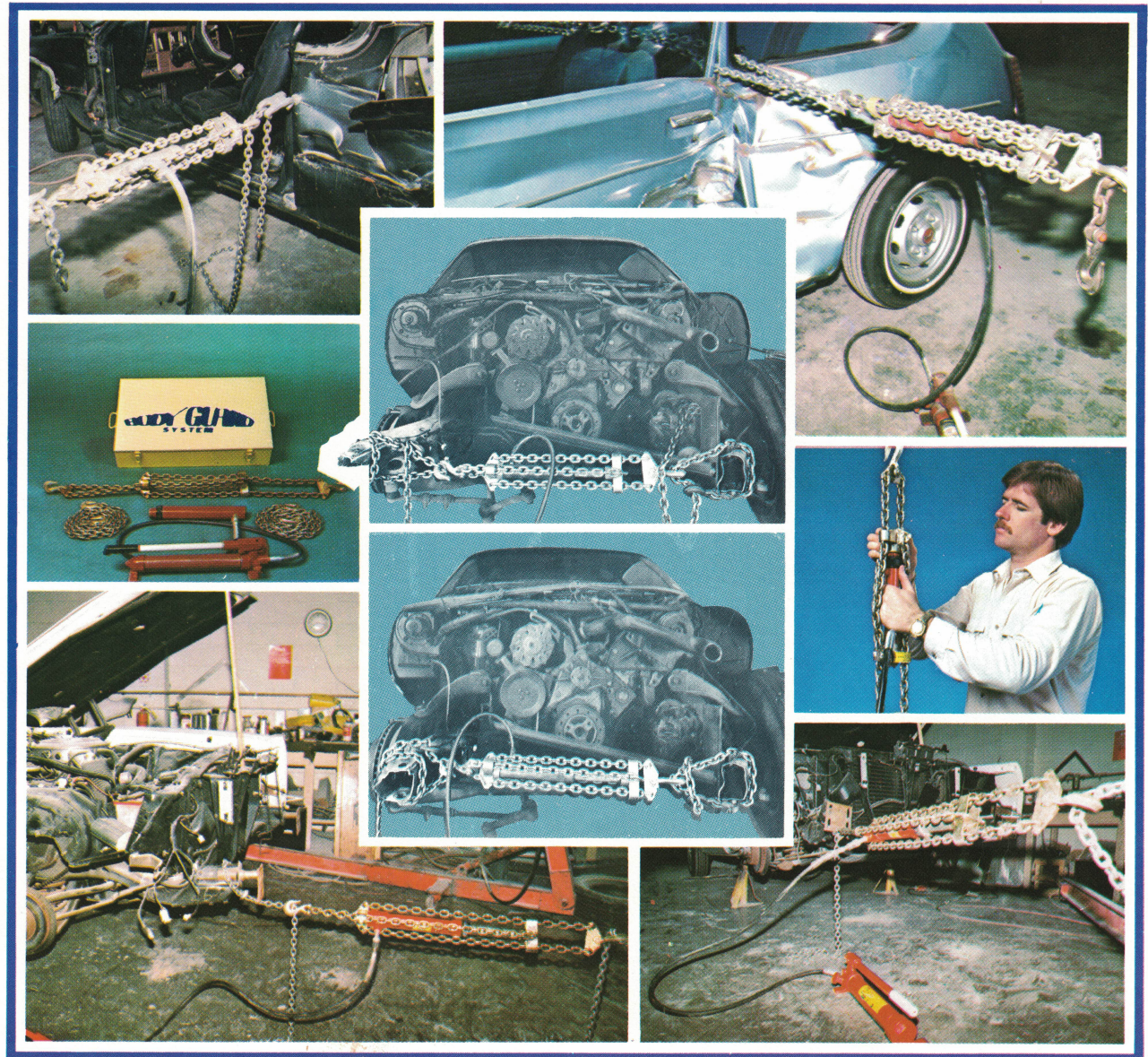

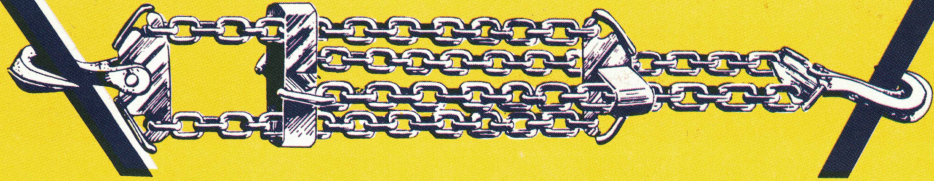

1

To prepare the Turben Puller for use is as simple as 1-2-3! First, insert the top end of your hydraulic ram in the Turben Puller.



2

Next, insert the bottom end into the Turben Puller collar. It's both simple and quick.

The Turben Puller Has Endless Applications

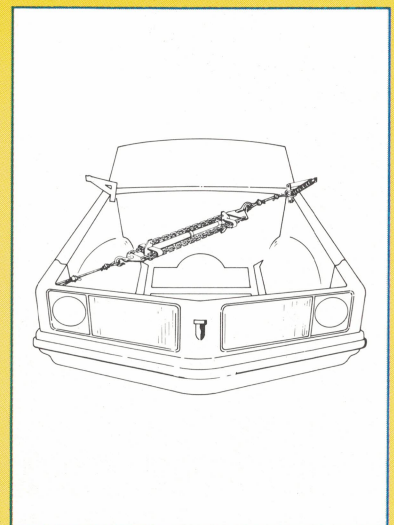
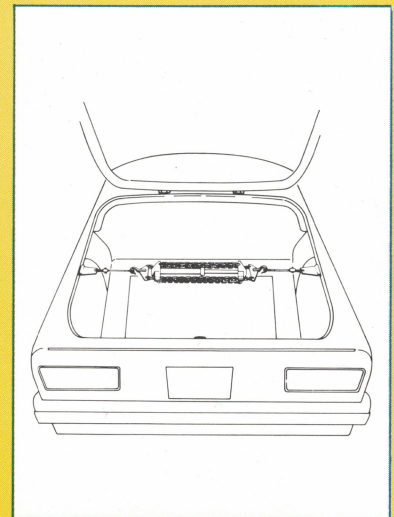
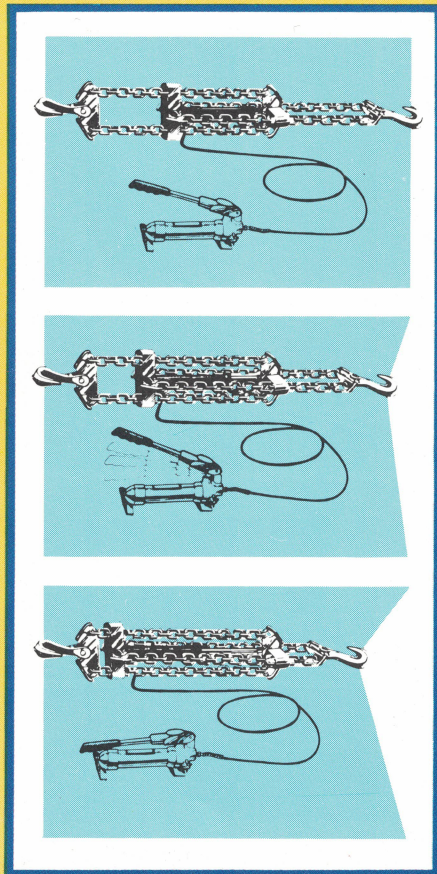
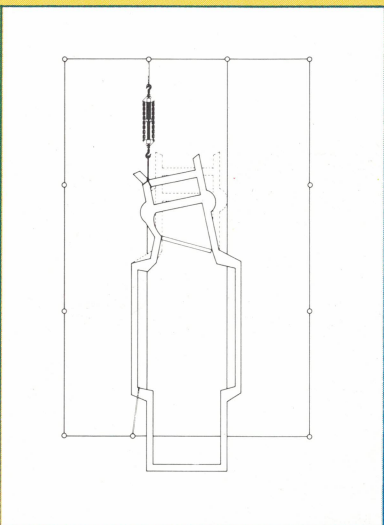
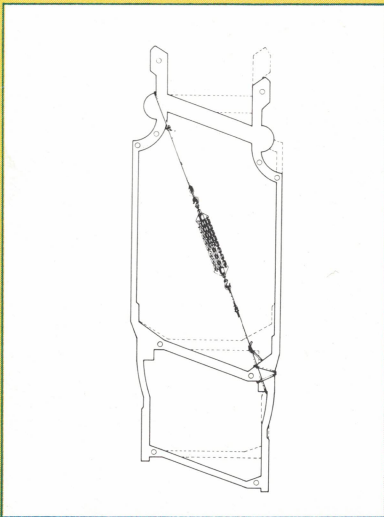

It Can Be Used With Any Standard Hydraulic Ram

Gives you immediate pull Where you want it. When you need it.

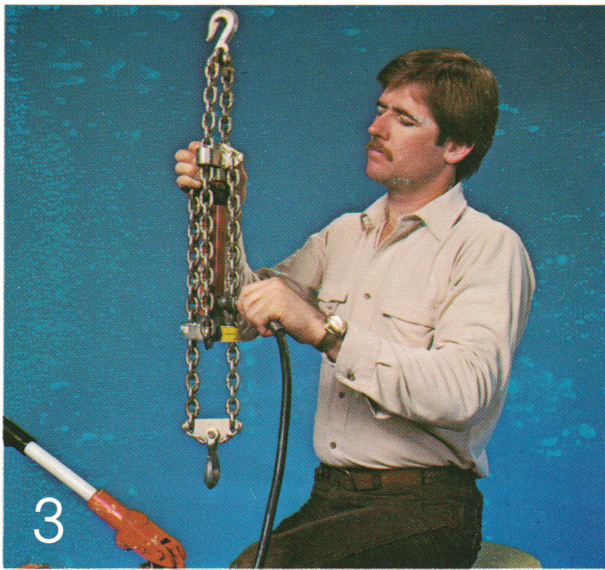

3

Activate your hydraulic pump.

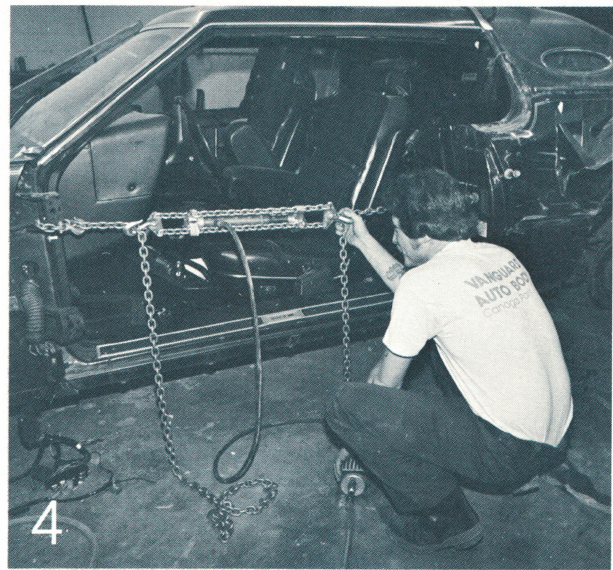

4

You're now ready to go with a fully controlled pull.

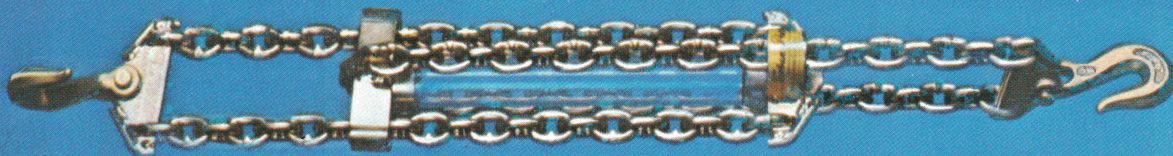

Ten Important Reasons Why YOU Should Own A TURBEN PULLER

- 1 It costs much less... YOU CAN AFFORD IT. Most units cost under \$100⁰⁰.
- 2 The return on your investment is almost immediate. The time saved on your first job computed into dollars could be equivalent to the purchase price of several Turben Pullers. Think about it!!!
- 3 Extremely light weight - easy to handle. The 4-ton unit weighs less than 8 pounds.
- 4 Does not take up valuable garage space. Hang it on the wall with the rest of your hand tools.
- 5 Designed to work extremely well in tight/limited spaces. Ideal for engine compartment work/ between frame horns - whatever.
- 6 Absolutely the best product for pulling/correct-
- 7 ing diamond frame problems. Eliminates large, cumbersome rigging chores.
- 7 Saves time and effort right from the start. The Turben Puller can be rigged in a fraction of the time. Time saved equals \$\$ in your pocket.
- 8 Absolutely no power efficiency loss. A 4-ton Turben Puller will pull the full four tons of the hydraulic ram.
- 9 A valuable tool for pulling cross members back into place. This is but one of the many Turben Puller uses.
- 10 The larger model has a pull capacity of up to 40,000 pounds. That's 20 tons! Probably much more pull than you'll ever need.



The Body Guard System

Designed to meet virtually any need for push or pull jobs in body shops. The Body Guard System includes as standard equipment:
 One 10-ton 10-inch Turben Puller
 One 10-ton 10-inch hydraulic ram
 One 10-ton hydraulic pump with hose
 Two 8-foot lengths of 5/16-inch chain with hooks
 One Safety Lime Yellow Equipment Box

The Turben Company, Inc.

Manufacturers of a complete line of automotive, industrial and safety pullers.

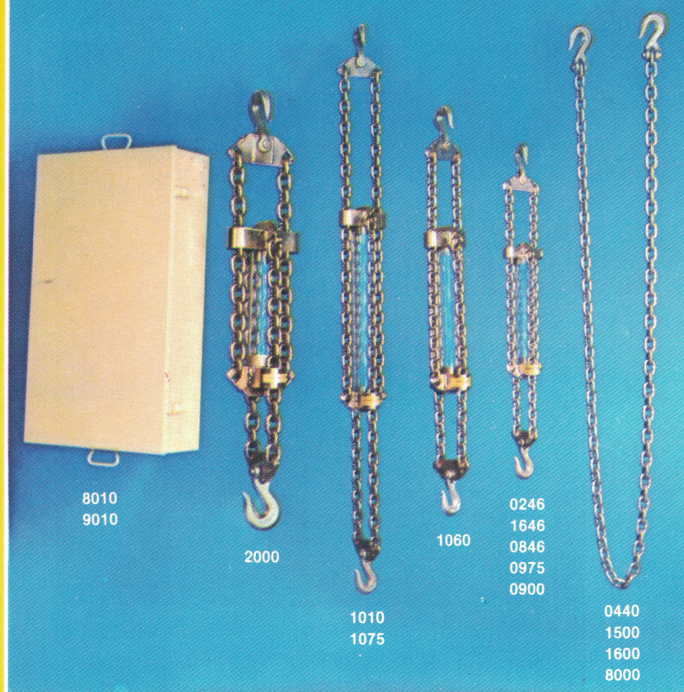

Specifications

Model #	Description
0246	BH 4 TON PULLER
1646	PF 4 TON PULLER
0846	HW 4 TON PULLER
0975	HW "SPRINT" 4 TON PULLER
0900	WM 4 TON PULLER
1060	10 TON PULLER
1010	10 TON 10 INCH PULLER
1075	10 TON SS PULLER
2000	20 TON PULLER
0440	By-Pass Chain
1500	By-Pass Chain
1600	By-Pass Chain
8000	By-Pass Chain
8010	Life Guard System
9010	Body Guard System

The purchase of a Turben Puller comes with a lifetime replacement guarantee.

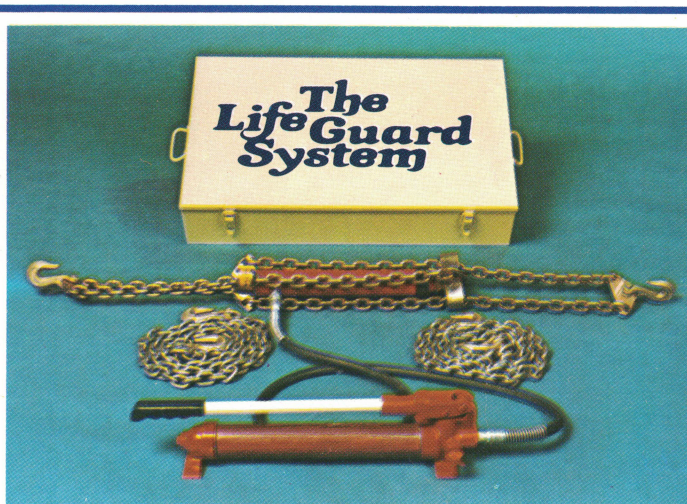

Life Guard System

Contains a broad range of equipment designed for fire, rescue and emergency uses. Simple and quick to use, the Life Guard System is a completely portable, light weight extrication system requiring no external power source to operate. It pulls or pushes up to 20,000 lbs.

TURBEN PULLER — U.S. Patent #3,893,650



Manufactured by

The Turben Company, Inc.

Manufacturers of automotive, industrial and safety pullers.

P.O. Box 5157 / Stateline, Nevada 89449
(916) 541-1913

DISTRIBUTED BY: